

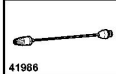

















Optional	
305  41988	307  41988
308  41992	311  41995
312  41996 1/4 MEG	314  41998 1/4 MEG
319  43417	322  43420
323  43421 16m	324  43422 20m
325  43423	326  43424
327  43425	328  43426
329  43427	330  43428
331  43429	334  43432 15m 5/16"



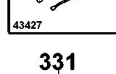

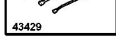

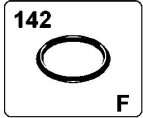
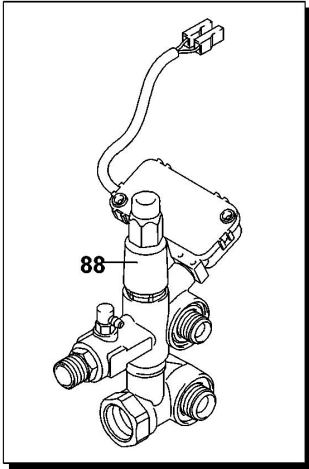
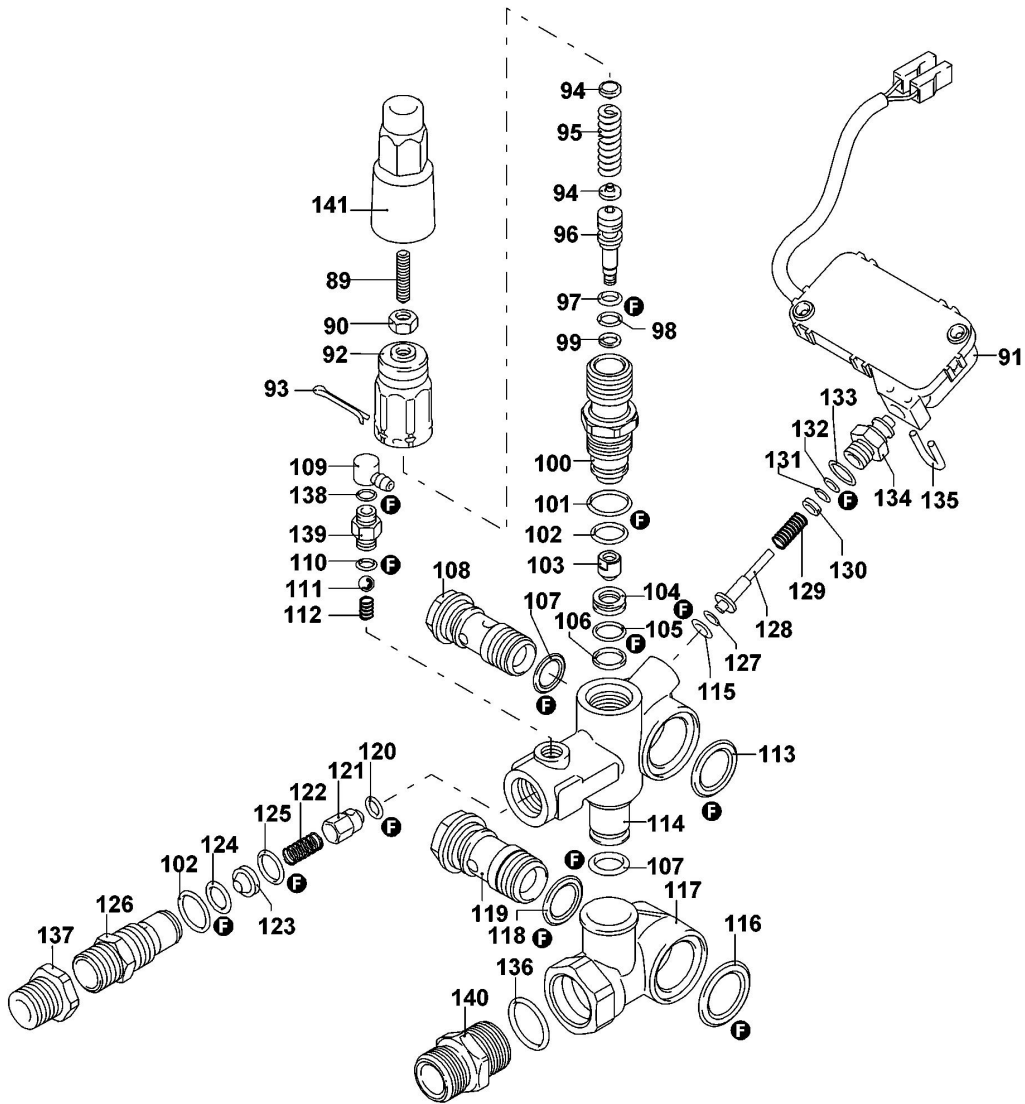
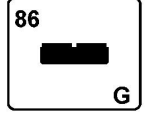
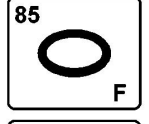
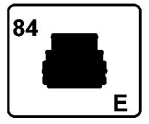
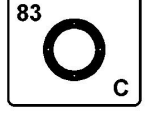
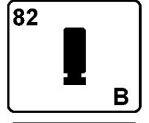
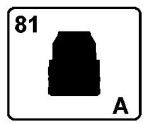
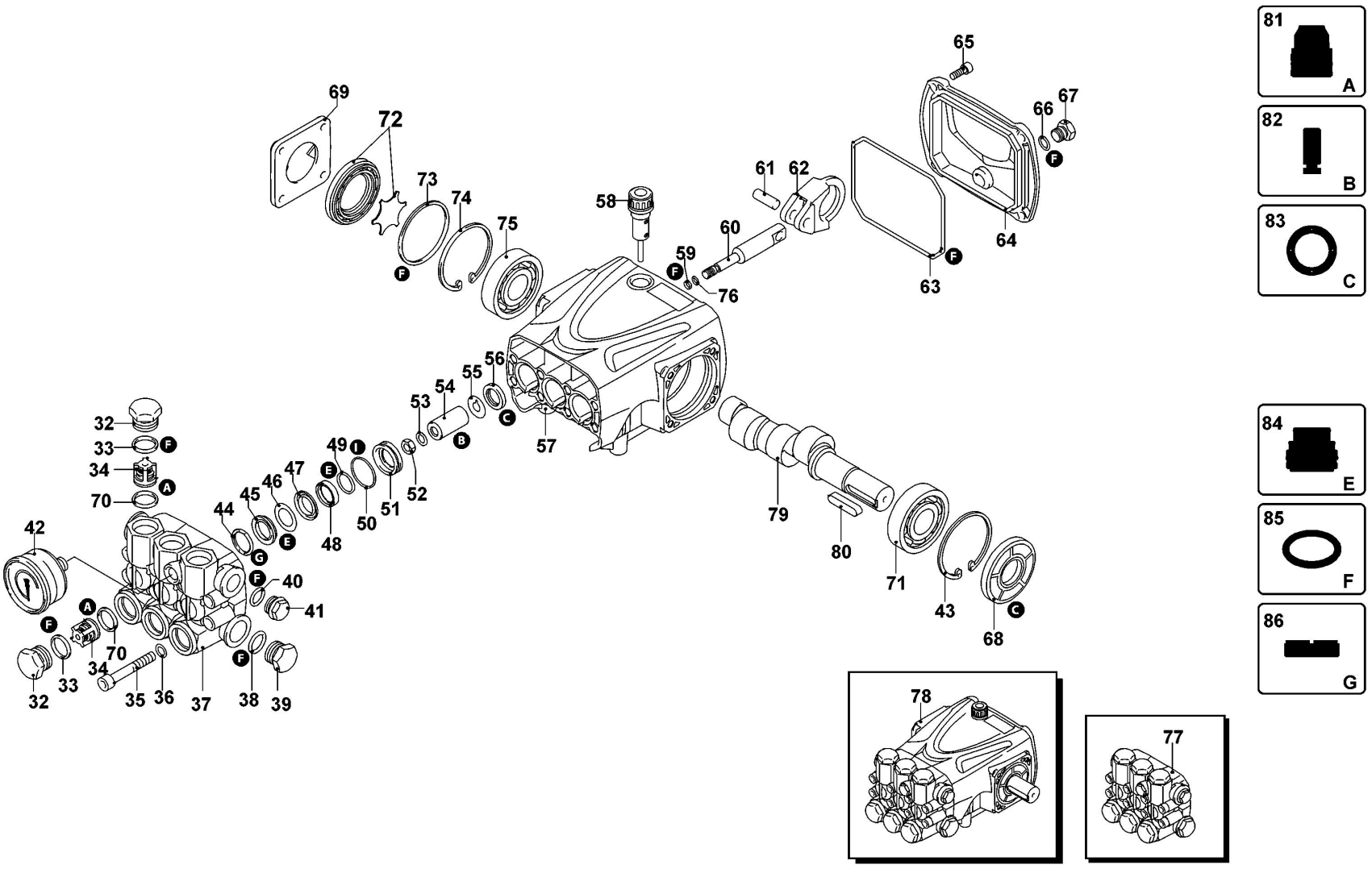
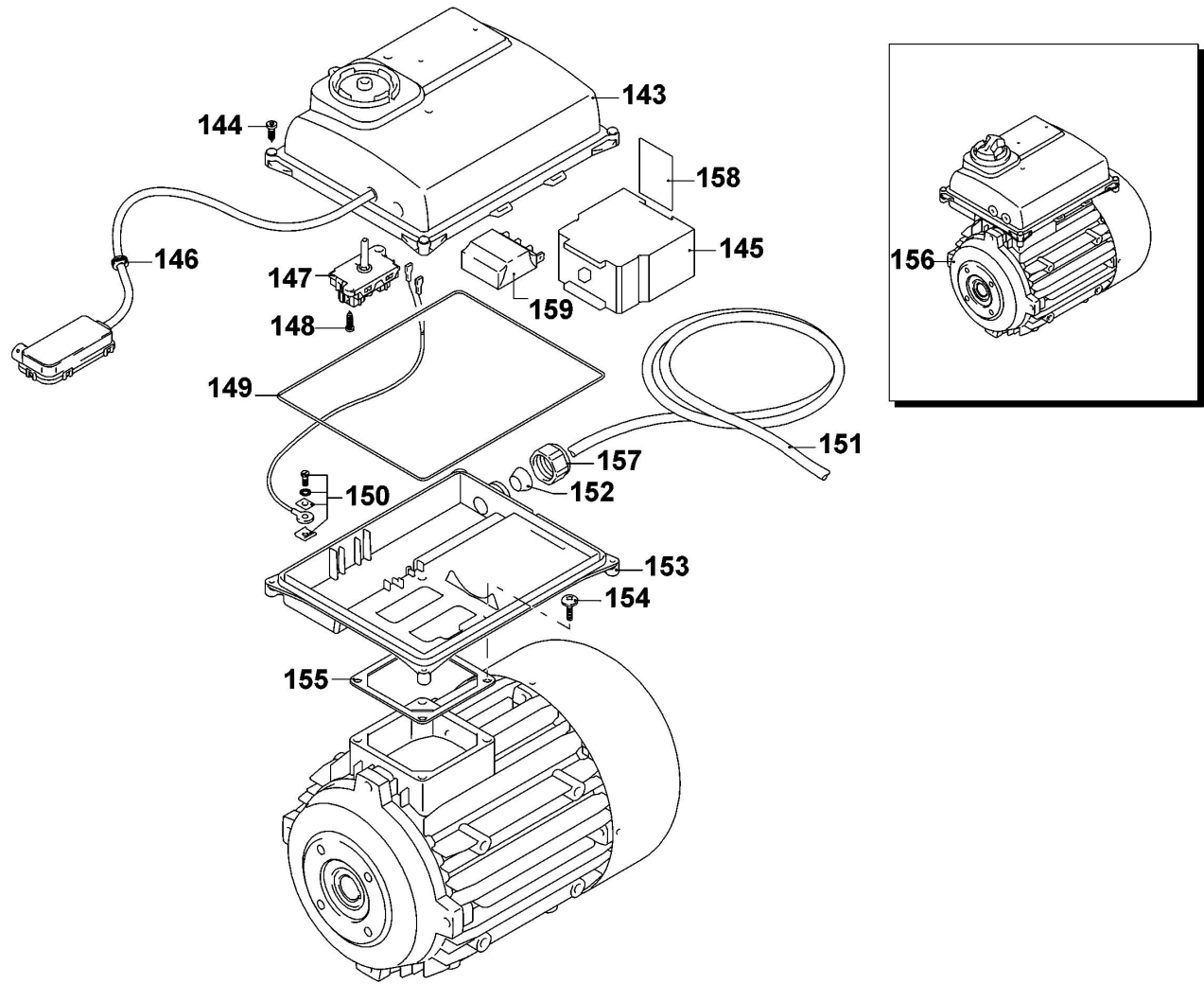
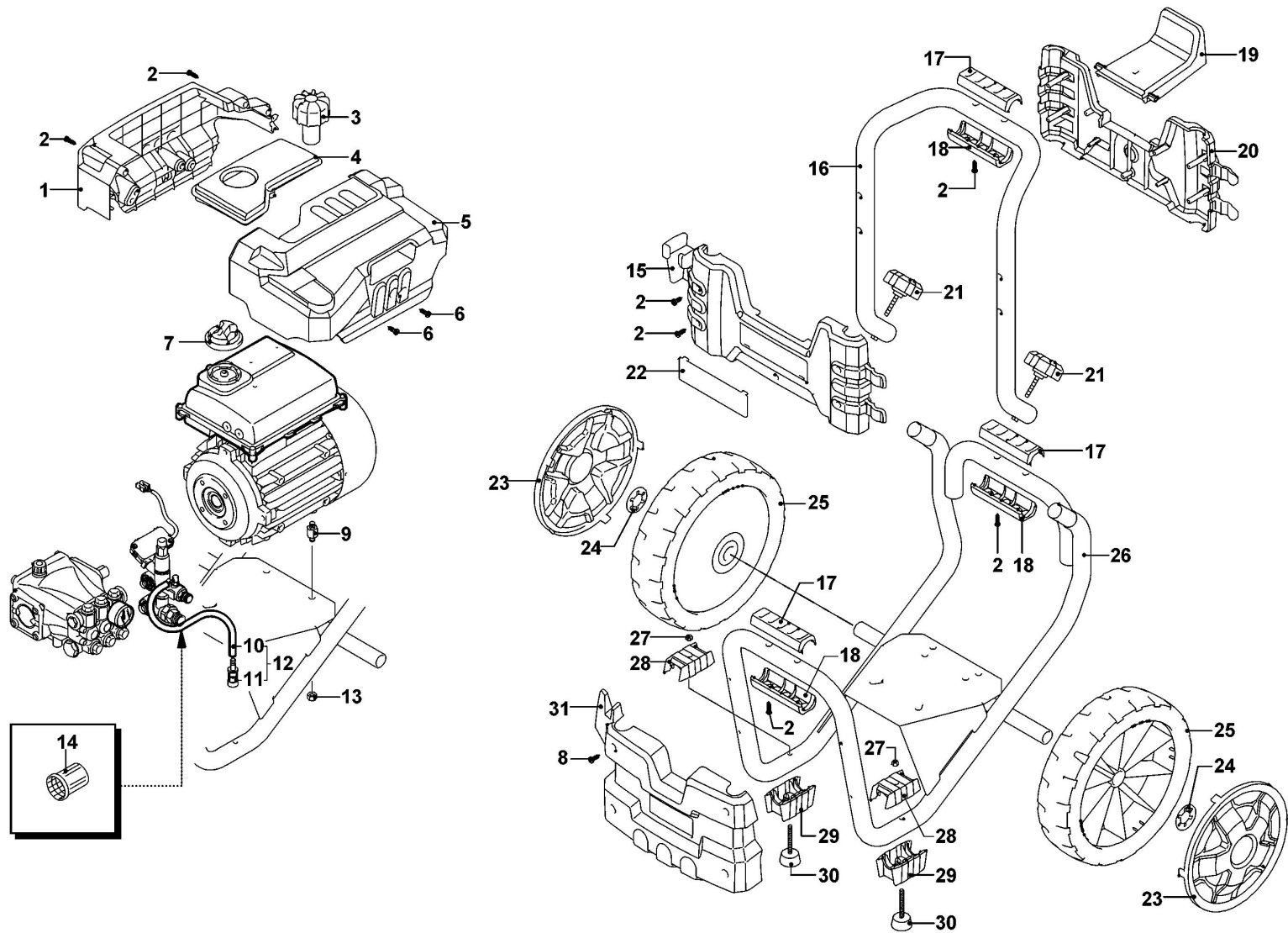

Parts List DXPW007E PRESSURE WASHER 1

Item	Part Number	Qty	Part Description	General Description	Other Info	Repair Inst	Markets
1	1004714-00	1	CASING			No	XJ
2	1004712-13	17	SCREW			No	XJ
3	1004712-40	1	KNOB			No	XJ
4	1004714-24	1	SUPPORT			No	XJ
5	1004713-99	1	CASING			No	XJ
6	1004709-59	4	SCREW			No	XJ
7	1004713-73	1	KNOB			No	XJ
8	1004712-12	4	SCREW			No	XJ
9	1004712-38	4	BOLT			No	XJ
10	1004710-70	1	HOSE			No	XJ
11	1004710-89	1	FILTER			No	XJ
12	1004710-68	1	HOSE SA			No	XJ
13	1004709-67	4	NUT			No	XJ
14	1004710-83	1	FILTER			No	XJ
15	1004713-77	1	GUARD			No	XJ
16	1004713-75	1	HANDLE			No	XJ
17	1004713-64	3	GUARD			No	XJ
18	1004713-65	3	GUARD			No	XJ
19	1004713-85	1	CARRIER			No	XJ
20	1004713-76	1	GUARD			No	XJ
21	1004714-12	2	KNOB			No	XJ
22	1004714-01	1	GUARD			No	XJ
23	1004713-82	2	GUARD			No	XJ
24	1004713-45	2	WASHER			No	XJ
25	1004713-44	2	WHEEL			No	XJ
26	1004713-74	1	FRAME			No	XJ
27	1004710-34	2	NUT			No	XJ
28	1004713-80	2	GUARD			No	XJ
29	1004713-79	2	GUARD			No	XJ
30	1004713-81	2	DAMPER			No	XJ
31	1004713-78	1	GUARD			No	XJ
32	1004710-20	6	PLUG			No	XJ

Parts List DXPW007E PRESSURE WASHER 1

Item	Part Number	Qty	Part Description	General Description	Other Info	Repair Inst	Markets
33	1004710-22	6	O RING			No	XJ
34	1004711-44	6	VALVE			No	XJ
35	1004710-01	8	SCREW			No	XJ
36	1004711-35	8	WASHER			No	XJ
37	1004713-19	1	HEAD SA			No	XJ
38	1004709-60	1	O RING			No	XJ
39	1004710-03	1	PLUG			No	XJ
40	1004709-90	1	O RING			No	XJ
41	1004711-91	1	PLUG			No	XJ
42	1004711-34	1	PRESSURE GAUGE			No	XJ
43	1004709-63	1	RING			No	XJ
44	1004711-80	3	RING			No	XJ
45	1004711-84	3	SEAL			No	XJ
46	1004713-10	3	RING			No	XJ
47	1004713-27	3	GUIDE			No	XJ
48	1004713-07	3	GASKET			No	XJ
49	1004713-11	3	RING			No	XJ
50	1004709-92	3	O RING			No	XJ
51	1004713-26	3	GUIDE			No	XJ
52	1004710-53	3	NUT			No	XJ
53	1004710-52	3	WASHER			No	XJ
54	1004711-79	3	PISTON			No	XJ
55	1004710-51	3	PLATE			No	XJ
56	1004710-57	3	SEAL			No	XJ
57	1004713-18	1	PUMP SA			No	XJ
58	1004710-10	1	PLUG			No	XJ
59	1004709-78	3	O RING			No	XJ
60	1004713-22	3	PISTON			No	XJ
61	1004713-23	3	PIN			No	XJ
62	1004713-21	3	CON ROD			No	XJ
63	1004709-86	1	O RING			No	XJ
64	1004713-20	1	COVER			No	XJ

Parts List DXPW007E PRESSURE WASHER 1

Item	Part Number	Qty	Part Description	General Description	Other Info	Repair Inst	Markets
65	1004713-08	4	SCREW			No	XJ
66	1004710-05	1	O RING			No	XJ
67	1004710-14	1	PLUG			No	XJ
68	1004713-34	1	RING			No	XJ
69	1004713-01	1	SUPPORT			No	XJ
70	1004710-15	6	O RING			No	XJ
71	1004711-93	1	BEARING			No	XJ
72	1004727-74	1	LEVEL			No	XJ
73	1004709-85	1	O RING			No	XJ
74	1004709-63	1	RING			No	XJ
75	1004711-93	1	BEARING			No	XJ
76	1004710-42	3	RING			No	XJ
77	1004727-75	1	HEAD SA			No	XJ
78	1004709-06	1	PUMP SA			No	XJ
79	1004713-35	1	CRANKSHAFT			No	XJ
80	1004713-09	1	KEY			No	XJ
81	1004708-95	1	VALVE KIT		A	No	XJ
82	1004708-93	1	PISTON KIT			No	XJ
83	1004709-30	1	SEALS KIT			No	XJ
84	1004709-31	1	SEALS KIT		Water	No	XJ
85	1004709-32	1	GASKET SET			No	XJ
86	1004708-92	1	RING			No	XJ
88	1004709-09	1	VALVE			No	XJ
89	1004712-72	1	SCREW			No	XJ
90	1004710-34	1	NUT			No	XJ
91	1004729-46	1	TERMINAL BOX			No	XJ
92	1004712-45	1	INSERT			No	XJ
93	1004712-46	1	PIN			No	XJ
94	1004711-87	2	PLATE			No	XJ
95	1004712-59	1	SPRING			No	XJ
96	1004712-58	1	PISTON			No	XJ
97	1004712-21	1	O RING			No	XJ

Parts List DXPW007E PRESSURE WASHER 1

Item	Part Number	Qty	Part Description	General Description	Other Info	Repair Inst	Markets
98	1004709-88	1	O RING			No	XJ
99	1004712-52	1	RING			No	XJ
100	1004712-60	1	GUIDE			No	XJ
101	1004710-49	1	O RING			No	XJ
102	1004709-75	5	O RING			No	XJ
103	1004712-20	1	SHUTTER			No	XJ
104	1004712-62	1	SEAT			No	XJ
105	1004709-91	1	O RING			No	XJ
106	1004712-61	1	RING			No	XJ
107	1004709-69	2	O RING			No	XJ
108	1004711-61	1	SCREW			No	XJ
109	1004712-33	1	CONNECTOR			No	XJ
110	1004709-78	1	O RING			No	XJ
111	1004710-50	1	BALL			No	XJ
112	1004711-70	1	SPRING			No	XJ
113	1004712-22	1	O RING			No	XJ
114	1004713-47	1	VALVE BODY			No	XJ
115	1004710-44	1	O RING			No	XJ
116	1004711-65	1	O RING			No	XJ
117	1004713-48	1	BODY			No	XJ
118	1004710-11	1	O RING			No	XJ
119	1004712-23	1	SCREW			No	XJ
120	1004712-14	1	O RING			No	XJ
121	1004712-50	1	SHUTTER			No	XJ
122	1004712-51	1	SPRING			No	XJ
123	1004712-49	1	INSERT			No	XJ
124	1004711-57	1	O RING			No	XJ
125	1004712-56	1	O RING			No	XJ
126	1004712-54	1	COUPLING			No	XJ
127	1004712-26	1	RING			No	XJ
128	1004712-25	1	PIN			No	XJ
129	1004712-24	1	SPRING			No	XJ

Parts List DXPW007E PRESSURE WASHER 1

Item	Part Number	Qty	Part Description	General Description	Other Info	Repair Inst	Markets
130	1004712-06	1	WASHER			No	XJ
131	1004710-63	1	O RING			No	XJ
132	1004713-50	1	RING			No	XJ
133	1004709-81	1	O RING			No	XJ
134	1004713-49	1	CONNECTOR			No	XJ
135	1004712-09	1	FORK			No	XJ
136	1004709-77	1	O RING			No	XJ
137	1004710-45	1	COUPLING			No	XJ
138	1004709-79	1	O RING			No	XJ
139	1004711-02	1	CONNECTOR			No	XJ
140	1004713-46	1	COUPLING			No	XJ
141	1004714-08	1	EXTENSION			No	XJ
142	1004709-40	1	GASKET SET			No	XJ
143	1004713-97	1	BOX			No	XJ
144	1004712-47	4	SCREW			No	XJ
145	1004712-41	1	CONTACT			No	XJ
146	1004712-04	1	GLAND			No	XJ
147	1004712-80	1	SWITCH			No	XJ
148	1004712-01	2	SCREW			No	XJ
149	1004713-95	1	O RING			No	XJ
150	1004710-67	1	CLAMP			No	XJ
151	1004711-76	1	CABLE			No	XJ
152	1004755-74	1	GASKET			No	XJ
153	1004713-96	1	PLATE			No	XJ
154	1004714-06	4	SCREW			No	XJ
155	1004711-75	1	GASKET			No	XJ
156	1004709-46	1	MOTOR			No	XJ
157	1004713-94	1	GLAND			No	XJ
158	1004714-07	1	GUIDE			No	XJ
159	1004712-39	1	BOARD			No	XJ
160	1004709-17	1	HANDLE SA			No	XJ
161	1004772-35	1	EXTENSION			No	XJ

Parts List DXPW007E PRESSURE WASHER 1

Item	Part Number	Qty	Part Description	General Description	Other Info	Repair Inst	Markets
162	1004712-02	2	O RING			No	XJ
163	1004714-11	1	HOSE			No	XJ
164	1004709-73	1	O RING			No	XJ
165	1004708-97	1	NOZZLE			No	XJ
305	1004719-43	1	EXTENSION		Optional	No	XJ
307	1004719-45	1	EXTENSION		Optional	No	XJ
308	1004719-46	1	EXTENSION		Optional	No	XJ
311	1004719-49	1	EXTENSION		Optional	No	XJ
312	1004719-50	1	NOZZLE		Optional	No	XJ
314	1004719-52	1	NOZZLE		Optional	No	XJ
319	1004719-57	1	BRUSH		Optional	No	XJ
322	1004719-60	1	HEAD SA		Optional	No	XJ
323	1004719-61	1	HOSE		Optional	No	XJ
324	1004719-62	1	HOSE		Optional	No	XJ
325	1004719-63	1	COUPLING		Optional	No	XJ
326	1004719-64	1	COUPLING		Optional	No	XJ
327	1004719-65	1	EXTENSION		Optional	No	XJ
328	1004719-66	1	EXTENSION		Optional	No	XJ
329	1004719-67	1	EXTENSION		Optional	No	XJ
330	1004719-68	1	EXTENSION		Optional	No	XJ
331	1004719-69	1	EXTENSION		Optional	No	XJ
334	1004719-72	1	HOSE		Optional	No	XJ